

INDUSTRIAL

POLY-FLO DOUBLE
CONTAINMENT
PIPING SYSTEM

**DOUBLE
SAFETY!**



INDUSTRIAL

PIPING SYSTEMS FOR INDUSTRIAL APPLICATIONS



The Plastics Experts.

AGRU Kunststofftechnik GmbH is a family-owned, high performance enterprise, headquartered in Austria with worldwide activities in production and sales of high-quality thermoplastic polymer products. The product group INDUSTRIAL PIPING SYSTEMS offers a wide range of pipes, fittings, valves and special components for the transport of aggressive media. In order to cover the various operating conditions in industrial applications, a multitude of materials such as PE, PP, PVDF and ECTFE are offered. Beside the variety of piping materials, a wide choice of piping products enables the construction of pipelines in a wide range of dimensions and flow rates. Especially for the transport of aggressive and acidic media, the excellent properties of plastic piping systems ensure high durability for many years and offer the user a sustainable solution.

The installation of INDUSTRIAL PIPING SYSTEMS can be performed by means of established welding technologies such as heating element butt-, heating element socket-, infrared- and electrofusion welding. Accessories facilitate the assembling and welding machines complete the large supply programme of AGRU.



Quality

AGRU operates a quality management system according to ISO 9001:2008. AGRU products comply with the requirements of international standards. Continuous third party inspections assure the high quality standard.



Supply Range:

SUPPLY RANGE PIPES 5 M



Material

PPR/PPR

PE 100-RC/PE 100-RC

Dimensions

DIM 50/32 – SDR17/11

DIM 90/63 – SDR17/11

DIM 160/110 – SDR17/11

SUPPLY RANGE FITTINGS

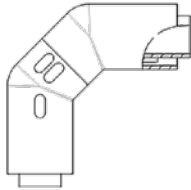

Elbow 90°
from 2 Elbows 45°
injection moulded + welded

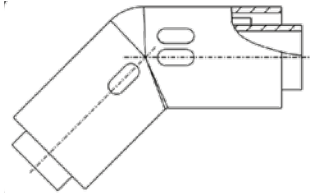

Elbow 45°
injection moulded

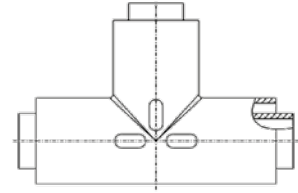

Tee
injection moulded

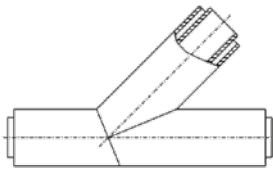

45° Tee
segmented

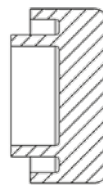

End Cap
machined

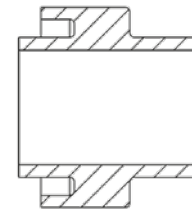

Dog Bone
End Termination
machined

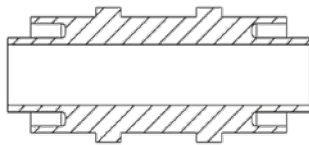

Dog Bone

- Restraint, Isolid
- Restraint, and flow through machined

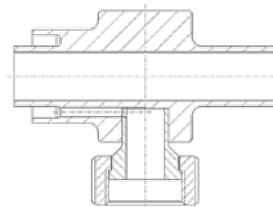

Measuring fitting
End Termination
machined



Induction E-Coupler
injection moulded

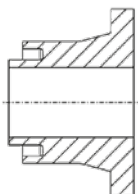

Stub Flange

- without flow through
- with flow through
- with flow through + groove for O-Ring machined

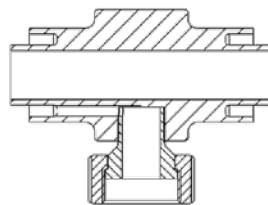

Measuring fitting

- one side leakage control
- both side leakage control machined

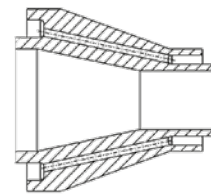

Reducer
concentric
machined

Other fittings are available on customer requests.



OIL AND GAS

Fracking,
Petrochemical
Exploration,
Flow-Lines



INDUSTRY

Chemical Industry,
Steel Galvanisation,
Automotive



MINING



INFRASTRUCTURE

Airport,
Power plants
(Waste drain)

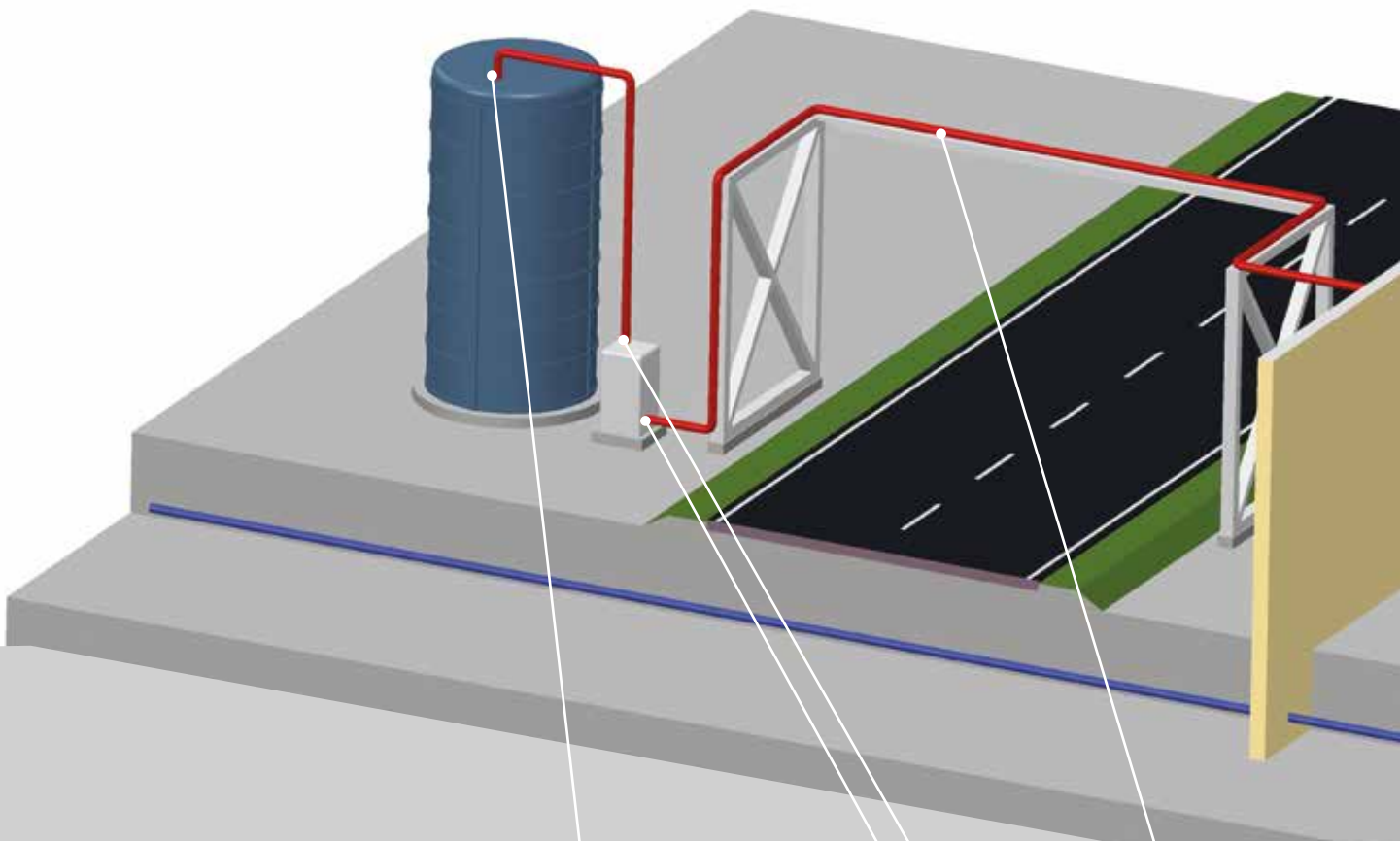

**TYPICAL
APPLICATIONS
FOR
POLY-FLO
PIPING
SYSTEMS**



DOG BONE

End Termination
Transition for double
to single wall
piping systems



STUB-FLANGE

For connections
where welding is not
possible or piping
system must be
dismountable



POLY-FLO PIPE

PPR grey and
PE 100-RC black,
suitable for above
and underground
installation



FOOD AND BEVERAGE

Microelectronic, Life-Science Industry, Laboratories, Waste drain pipe, Chemical process piping



WATER AND WASTE WATER TREATMENT

Chemical feed lines, Chlorination pipes

APPLICATION AREAS FOR POLY-FLO PIPING SYSTEMS

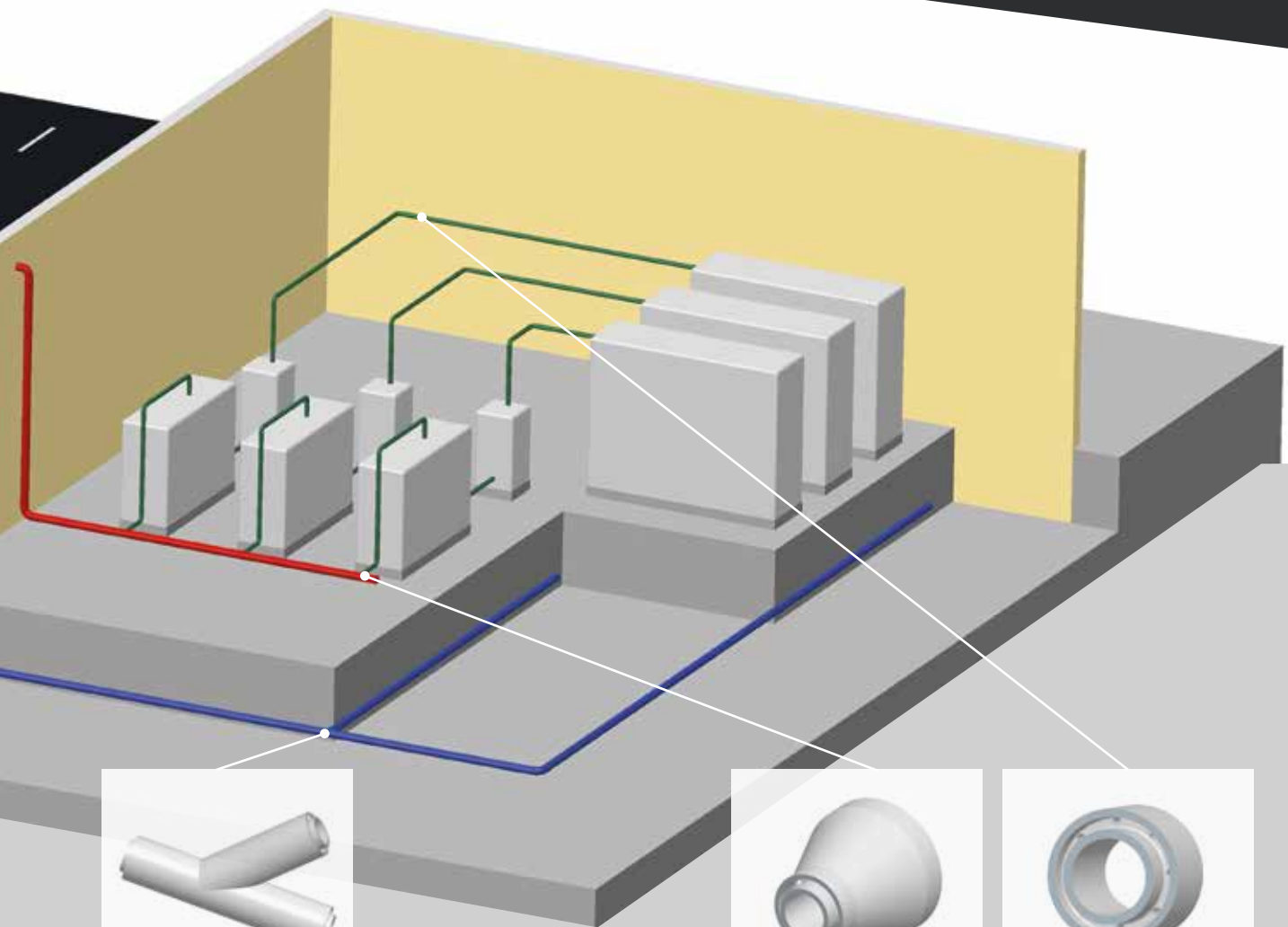

45° TEE

Specially for drainage applications with perfect flow



REDUCER

Machined for transition for large to small diameter



DOG BONE

Fixing of the piping system for higher temperature differences

Poly-Flo welding method

Simultaneous welding

The simultaneous welding is used successfully for the AGRU double containment piping systems since many years. This welding method is also applicable for our new Poly-Flo system. The main advantages of this welding method are the fast installation time and the possibility of using standard butt welding machines.

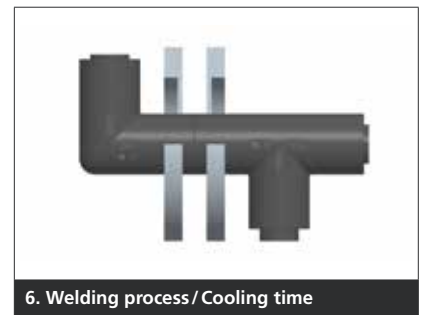
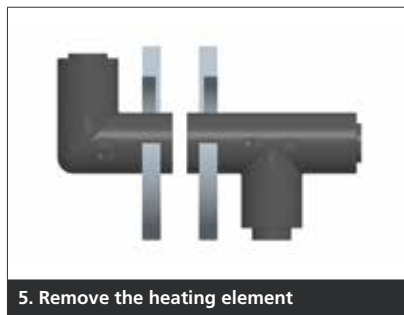
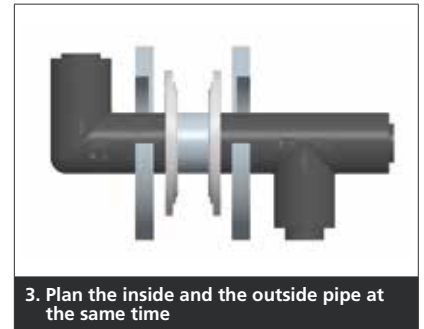
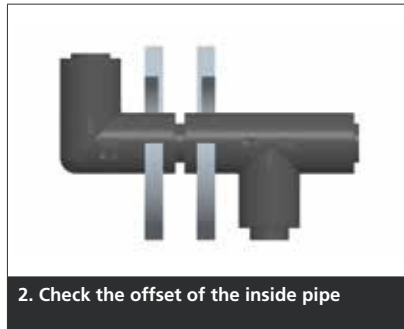
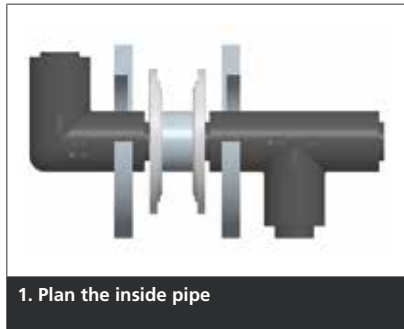

Poly-Flo welding method

Cascade welding

With butt welding, infrared welding and induction welding

Advantages:

- The weld seam of the inside pipe can be checked visually.
- A pressure test on the inside pipe is possible before the outside pipe will be welded.

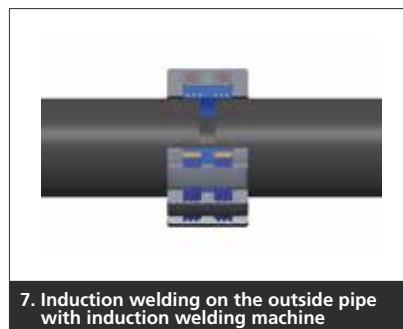
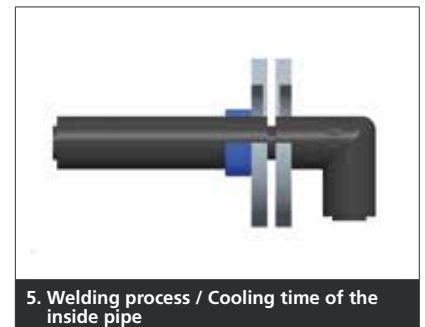
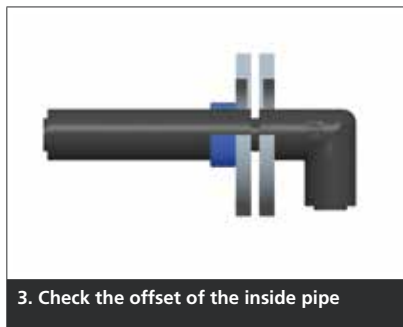
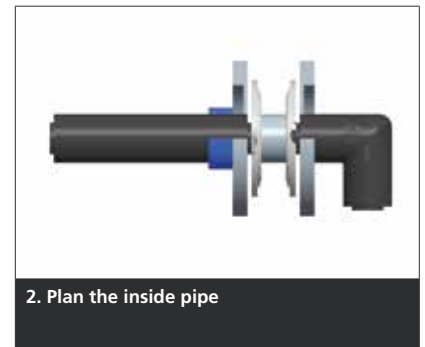
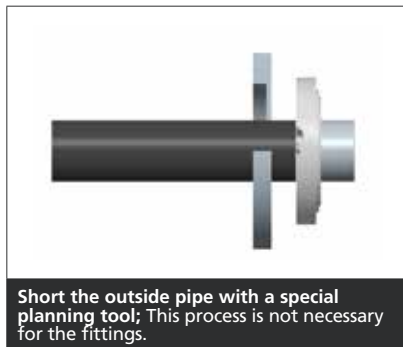

Piping system with double safety

The AGRU double containment pipes have been used very successfully in a wide range of applications since many years. They fulfil today's high requirements in the field of chemical process engineering. Our new Poly-Flo system is an enlargement of our double-containment piping system which has proven its worth over years. For leak detection in the double containment piping, different leak detection methods are offered.

AGRU double containment piping systems ensure a system which is perfectly designed and adapted for the application (high pressure resistance of the media pipe, materials which are resistant to the transported media). Furthermore, space-saving options with reduced space for the leak detection are available.



Induction welding machine



The Plastics Experts.

Your distributor



OFFICE AND CENTRAL WAREHOUSE

Pol. Ind. El Cascajal. C/ Gaviotas, 1, 28320, Pinto, Madrid.
comercial@grupoquero.com www.agruquero.com
T: +34 91 692 71 60 F: +34 91 692 60 57

1217

agru Kunststofftechnik Gesellschaft m.b.H.
Ing.-Pesendorfer-Strasse 31
4540 Bad Hall, Austria

T. +43 7258 7900
F. +43 7258 790 - 2850
office@agru.at



www.agru.at